

Model / Model		A175-400Nm 1250-1,60
Yük-Yolcu / Load-Person		1250 Kg (16 Person)
Hız / Speed		1,6 m/s
Aski / Roping		2 / 1
Kasnak-Hatve / Sheave-Pitch		ø210 x 7 x ø8 / 14
V Kanal Açısı / V Groove Angle		45°
Enkoder / Encoder		Endat / Sincos / Biss-C
Fren / Brake Magnet		207 V DC
Duty Cycle / Görev Faktörü		53 40%
Machine Weight / Makine Ağırlığı		260Kg
Maks. Statik Yük / Max. Static Load		6000Kg (2/1)
Tork / Torque		400 NM
Bağlantı / Connect		(Δ) Delta
Devir / Motor RPM		290 RPM
Frekans / Frequency		106,33 Hz
Kutup Sayısı / Number of Poles		44 Poles
Motor Gücü / Motor Power		12,15 Kw
Akım / Current		27,7 A
Voltaj / Terminal Voltage		331 V AC
Cosφ / Cos φ		0,88

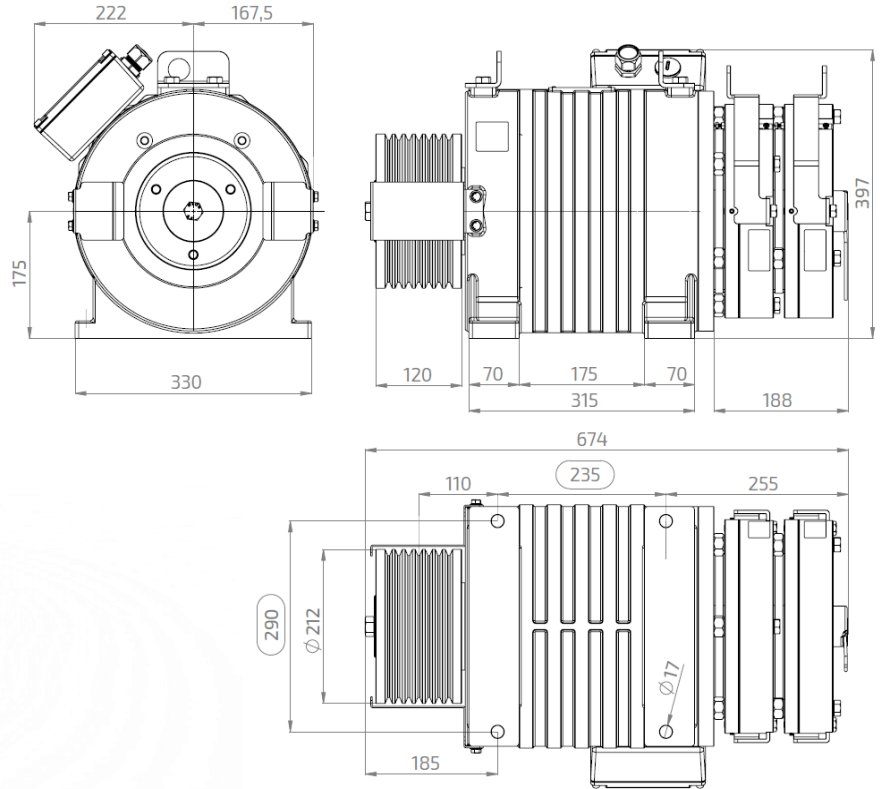

Astes Asansör ölçüler ve veriler üzerinde değişiklik yapma hakkına sahiptir.

The dimensions and data are subject to change without notice.